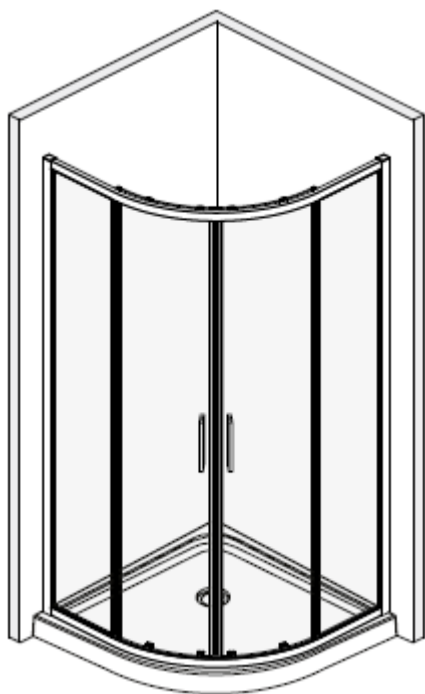

BLIX SLIM

Katalog dílů

Platnost od 06/2019

RAVAK®

BLSCP4 – 80



Číslo dílu	Název v MN	Počet	SIČ	Název
1	Profile cap	2	XND0000025	Krytka profilu SJ1103
2	Wall jamb	2	XND0000064	Ustavovací profil, JG-AL0880-04 (1950 mm)
3	ST4x40	8	XND0000094	Vrut BLS 4x40
4	Wall profile cap	2	XND0000026	Profil JG-AL0882-04 (1879 mm)
5	Fixed panel	2	XND0000010	Sklo 6,0x1900x291 čiré BL-S22 Ravak-05
6	Fixed panel seal strip	2	XND0000042	Těsnící profil 304-06-20 (1877 mm)
7	Door panel seal strip	2	XND0000045	Těsnící profil 304-06-24 (1936 mm)
8	Moving door	2	XND0000008	Sklo dveře 6,0x1936x346 čiré BL-S22 Ravak-07
9	Wall anchor	8	XND0000061	Kotva AQ průměr 6
10	Magnet seal	2	XND0000021	Magnet 308GW-6-20, (1936 mm)
11	Handle	1	XND0000015	Madlo JG-AL0888-01
11	Handle	1	XND0000016	Madlo JG-AL0888-02
11	Handle	1	XND0000017	Záslepka madla SJ1050, sada 4ks
11	Handle	2	XND0000018	Šroub madla 8x6x4, sada 2ks
12	Bottom Wheels	4	XND0000002	Spodní kolečko dveří HL047
13	Rail	2	XND0000040	Vodící profil, JG-AL0895-14 (1341 mm)
14	Top wheels	4	XND0000055	Horní kolečko dveří HL046
15	Handle cap	4	XND0000014	Krytka madla SJ744

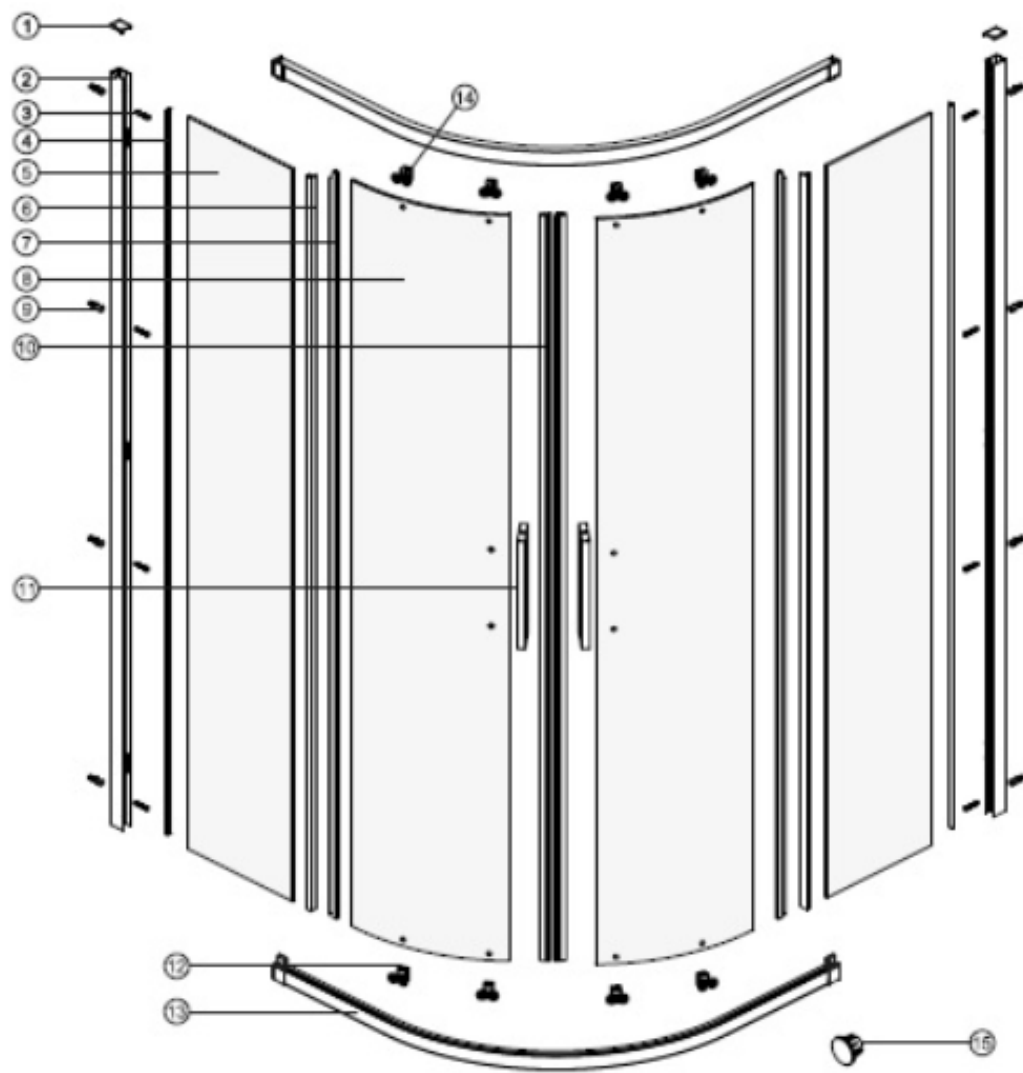

BLSCP4 – 90

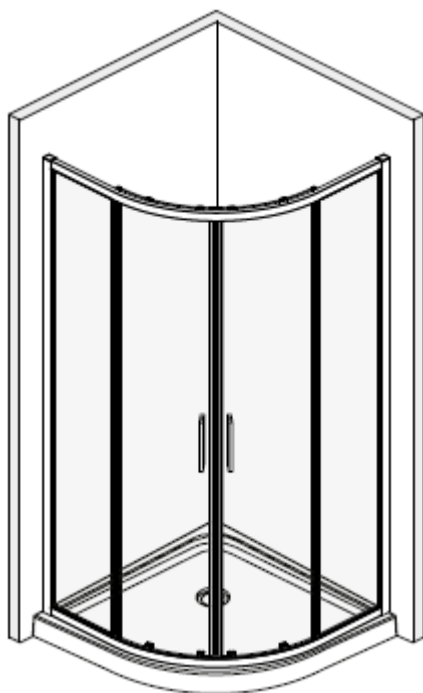

Číslo dílu	Název v MN	Počet	SIČ	Název
1	Profile cap	2	XND0000025	Krytka profilu SJ1103
2	Wall jamb	2	XND0000064	Ustavovací profil, JG-AL0880-04 (1950 mm)
3	ST4x40	8	XND0000094	Vrut BLS 4x40
4	Wall profile cap	2	XND0000026	Profil JG-AL0882-04 (1879 mm)
5	Fixed panel	2	XND0000010	Sklo 6,0x1900x391 čiré BL-S22 Ravak-06
6	Fixed panel seal strip	2	XND0000042	Těsnící profil 304-06-20 (1877 mm)
7	Door panel seal strip	2	XND0000045	Těsnící profil 304-06-24 (1936 mm)
8	Moving door	2	XND0000008	Sklo dveře 6,0x1936x346 čiré BL-S22 Ravak-07
9	Wall anchor	8	XND0000061	Kotva AQ průměr 6
10	Magnet seal	2	XND0000021	Magnet 308GW-6-20, (1936 mm)
11	Handle	1	XND0000015	Madlo JG-AL0888-01
11	Handle	1	XND0000016	Madlo JG-AL0888-02
11	Handle	1	XND0000017	Záslepka madla SJ1050, sada 4ks
11	Handle	2	XND0000018	Šroub madla 8x6x4, sada 2ks
12	Bottom Wheels	4	XND0000002	Spodní kolečko dveří HL047
13	Rail	2	XND0000040	Vodící profil, JG-AL0895-14 (1341 mm)
14	Top wheels	4	XND0000055	Horní kolečko dveří HL046
15	Handle cap	4	XND0000014	Krytka madla SJ744

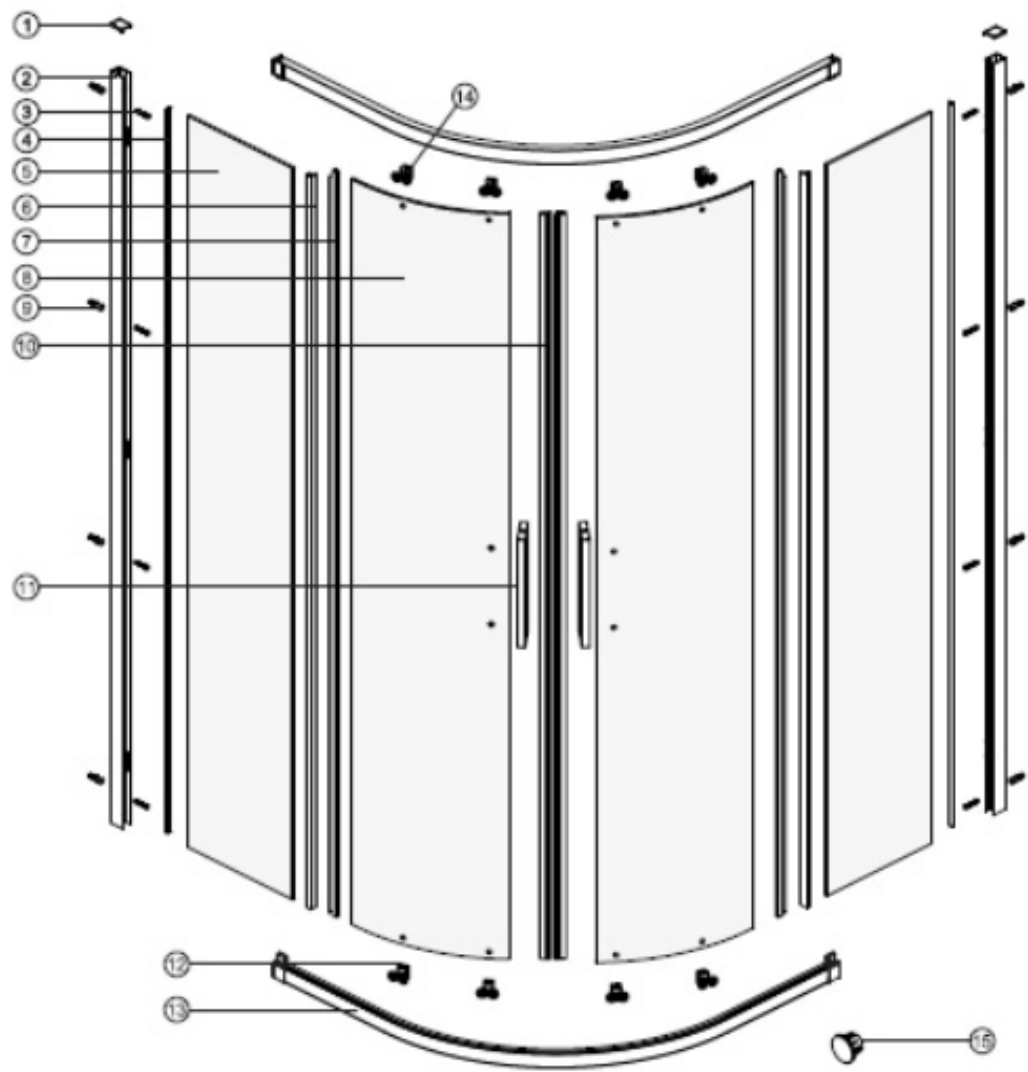

BLSRV2 – 80



Číslo dílu	Název v MN	Počet	SIČ	Název
1	Top track	2	XND0000032	Vodící profil, JG-AL0879-03L (751,5 mm)
2	Channel cap extrusion	2	XND0000025	Krytka profilu SJ1103
3	Wall track	2	XND0000064	Ustavovací profil, JG-AL0880-04 (1950 mm)
4	Channel cap	2	XND0000026	Profil JG-AL0882-04 (1879 mm)
5	Fixed panel	2	XND0000081	Sklo 6,0x1900x338čiré BL-S22 Ravak-02
6	Top wheels	4	XND0000055	Horní kolečko dveří HL046
7	Wall anchor	8	XND0000061	Kotva AQ průměr 6
8	ST4x40 Screw	8	XND0000094	Vrut BLS 4x40
9	Fixed panel seal strip	2	XND0000043	Těsnící profil 304-06-24 (1877 mm)
10	Door panel seal strip	2	XND0000044	Těsnící profil 304-06-24 (1935 mm)
11	Door panel	2	XND0000080	Sklo 6,0x1935x400čiré BL-S22 Ravak-01
12	Magnet seal	2	XND0000020	Magnet 308GA-6, (1935 mm)
13	Handle	1	XND0000015	Madlo JG-AL0888-01
13	Handle	1	XND0000016	Madlo JG-AL0888-02
13	Handle	1	XND0000017	Záslepka madla SJ1050, sada 4ks
13	Handle	2	XND0000018	Šroub madla 8x6x4, sada 2ks
14	Bottom wheels	2	XND0000002	Spodní kolečko dveří HL047
15	Bottom track	2	XND0000036	Vodící profil, JG-AL0879-03R (751,5 mm)
16	Track connector	2	XND0000006	Rohová spojka ZJ552
17	Handle cap	4	XND0000014	Krytka madla SJ744

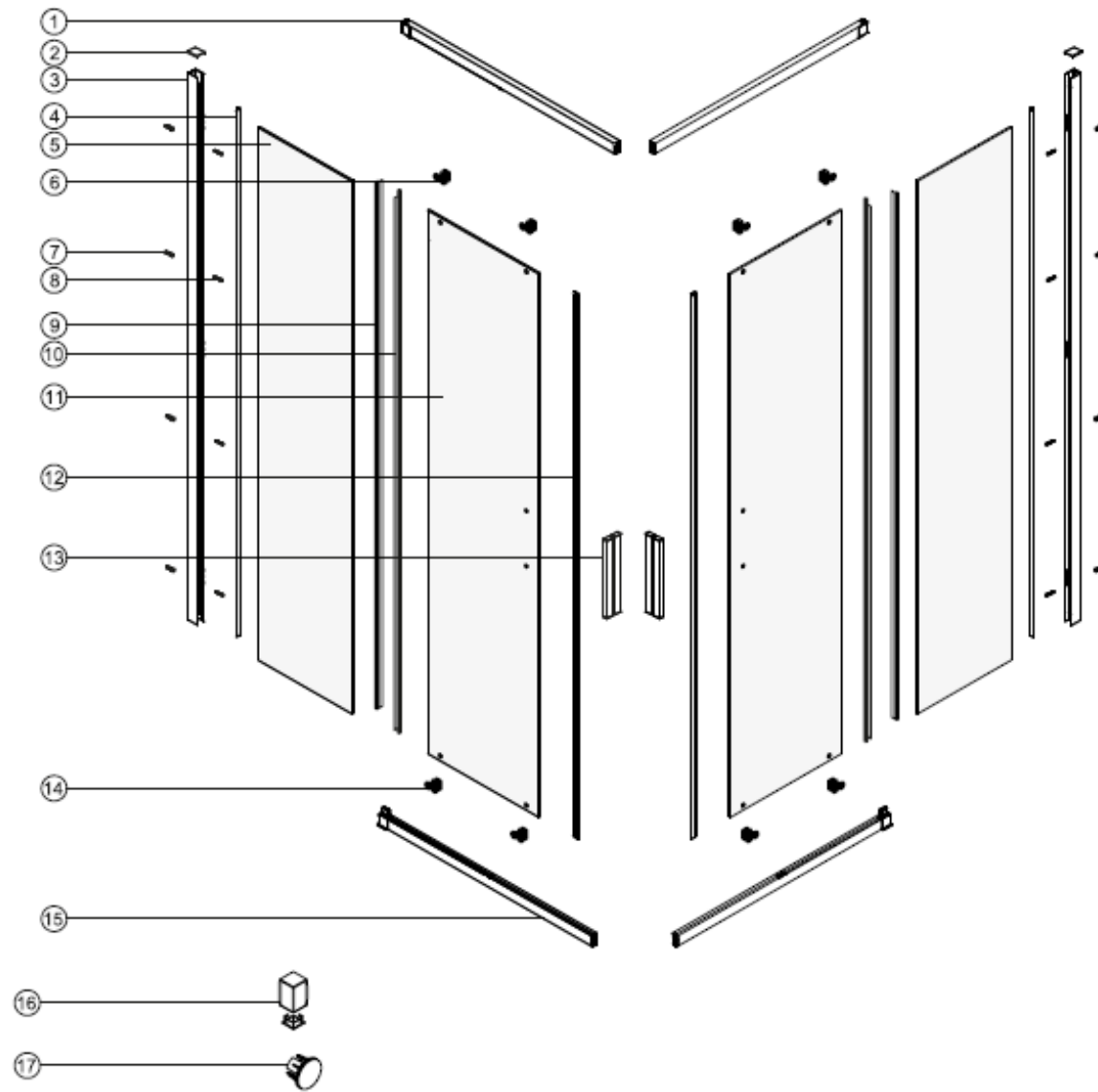

BLSRV2 – 90



Číslo dílu	Název v MN	Počet	SIČ	Název
1	Top track	2	XND0000033	Vodící profil, JG-AL0879-04L (851,5 mm)
2	Channel cap extrusion	2	XND0000025	Krytka profilu SJ1103
3	Wall track	2	XND0000064	Ustavovací profil, JG-AL0880-04 (1950 mm)
4	Channel cap	2	XND0000026	Profil JG-AL0882-04 (1879 mm)
5	Fixed panel	2	XND0000096	Sklo 6,0x1900x338čiré BL-S22 Ravak-04
6	Top wheels	4	XND0000055	Horní kolečko dveří HL046
7	Wall anchor	8	XND0000061	Kotva AQ průměr 6
8	ST4x40 Screw	8	XND0000094	Vrut BLS 4x40
9	Fixed panel seal strip	2	XND0000043	Těsnící profil 304-06-24 (1877 mm)
10	Door panel seal strip	2	XND0000044	Těsnící profil 304-06-24 (1935 mm)
11	Door panel	2	XND0000082	Sklo 6,0x1935x450čiré BL-S22 Ravak-03
12	Magnet seal	2	XND0000020	Magnet 308GA-6, (1935 mm)
13	Handle	1	XND0000015	Madlo JG-AL0888-01
13	Handle	1	XND0000016	Madlo JG-AL0888-02
13	Handle	1	XND0000017	Záslepka madla SJ1050, sada 4ks
13	Handle	2	XND0000018	Šroub madla 8x6x4, sada 2ks
14	Bottom wheels	2	XND0000002	Spodní kolečko dveří HL047
15	Bottom track	2	XND0000037	Vodící profil, JG-AL0879-04R (851,5 mm)
16	Track connector	2	XND0000006	Rohová spojka ZJ552
17	Handle cap	4	XND0000014	Krytka madla SJ744

BLSDP2 – 100

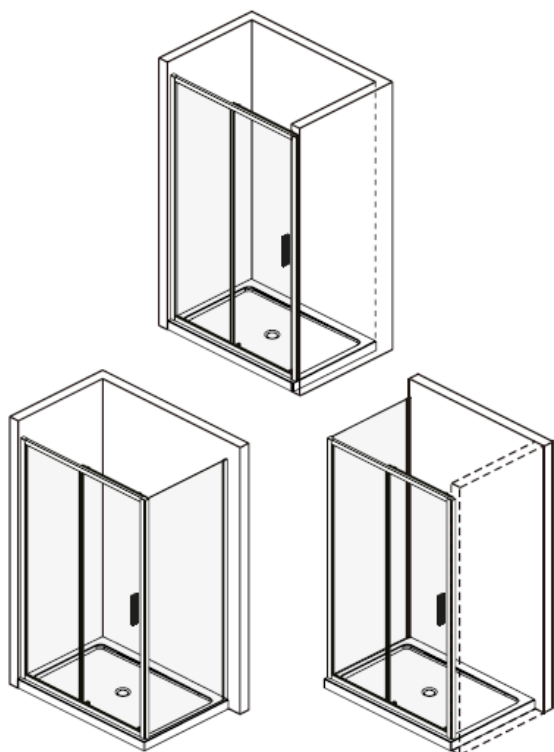

Číslo dílu	Název v MN	Počet	SIČ	Název
1	Profile cap	2	XND0000025	Krytka profilu SJ1103
2	Wall jamb	1	XND0000064	Ustavovací profil, JG-AL0880-04 (1950 mm)
3	ST4x40 Screw	4	XND0000094	Vrut BLS 4x40
4	Wall profile cap	2	XND0000026	Profil JG-AL0882-04 (1879 mm)
5	Fixed panel	1	XND0000085	Sklo 6,0x1900x452 čiré BL-S22 Ravak-09
6	Fixed panel seal strip	1	XND0000043	Těsnící profil 304-06-24 (1877 mm)
7	Door panel seal strip	1	XND0000045	Těsnící profil 304-06-24 (1936 mm)
8	Moving door	1	XND0000084	Sklo 6,0x1936x522 čiré BL-S22 Ravak-08
9	Wall anchor	8	XND0000061	Kotva AQ průměr 6
10	Rail	1	XND0000034	Vodící profil, JG-AL0895-16L (956,5 mm)
11	Top wheels	2	XND0000055	Horní kolečko dveří HLO46
12	Wall jamb	1	XND0000091	Ustavovací profil DP2, JG-AL0887-04 (1950 mm)
13	Handle	1	XND0000015	Madlo JG-AL0888-01
13	Handle	1	XND0000016	Madlo JG-AL0888-02
13	Handle	1	XND0000017	Záslepka madla SJ1050, sada 4ks
13	Handle	2	XND0000018	Šroub madla 8x6x4, sada 2ks
14	ST4x50 Screw	4	XND0000095	Vrut BLS 4x50
15	Water retaining gasket	1	XND0000009	Těsnění JT0296 (1947)
16	Bottom wheels	2	XND0000002	Spodní kolečko dveří HLO47
17	Rail	1	XND0000038	Vodící profil, JG-AL0895-16R (956,5 mm)
18	Handle cap	2	XND0000014	Krytka madla SJ744

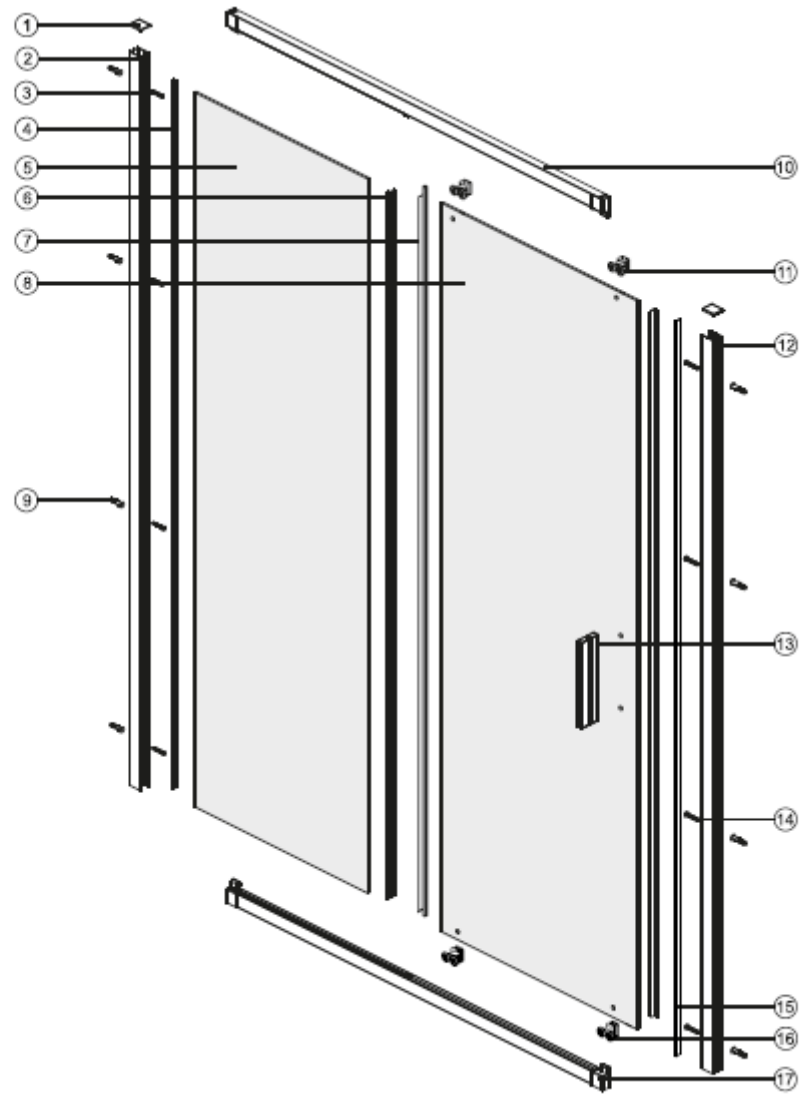

BLSDP2 – 120

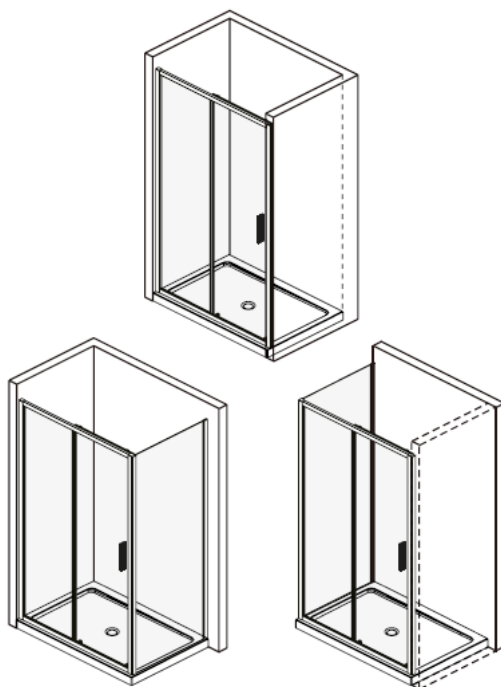

Číslo dílu	Název v MN	Počet	SIČ	Název
1	Profile cap	2	XND0000025	Krytka profilu SJ1103
2	Wall jamb	1	XND0000064	Ustavovací profil, JG-AL0880-04 (1950 mm)
3	ST4x40 Screw	4	XND0000094	Vrut BLS 4x40
4	Wall profile cap	2	XND0000026	Profil JG-AL0882-04 (1879 mm)
5	Fixed panel	1	XND0000087	Sklo 6,0x1900x552 čiré BL-S22 Ravak-11
6	Fixed panel seal strip	1	XND0000043	Těsnící profil 304-06-24 (1877 mm)
7	Door panel seal strip	1	XND0000045	Těsnící profil 304-06-24 (1936 mm)
8	Moving door	1	XND0000086	Sklo 6,0x1936x622 čiré BL-S22 Ravak-10
9	Wall anchor	8	XND0000061	Kotva AQ průměr 6
10	Rail	1	XND0000035	Vodící profil, JG-AL0895-17L (1156,5 mm)
11	Top wheels	2	XND0000055	Horní kolečko dveří HL046
12	Wall jamb	1	XND0000091	Ustavovací profil DP2, JG-AL0887-04 (1950 mm)
13	Handle	1	XND0000015	Madlo JG-AL0888-01
13	Handle	1	XND0000016	Madlo JG-AL0888-02
13	Handle	1	XND0000017	Záslepka madla SJ1050, sada 4ks
13	Handle	2	XND0000018	Šroub madla 8x6x4, sada 2ks
14	ST4x50 Screw	4	XND0000095	Vrut BLS 4x50
15	Water retaining gasket	1	XND0000009	Těsnění JT0296 (1947)
16	Bottom wheels	2	XND0000002	Spodní kolečko dveří HL047
17	Rail	1	XND0000039	Vodící profil, JG-AL0895-17R (1156,5 mm)
18	Handle cap	2	XND0000014	Krytka madla SJ744

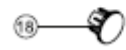
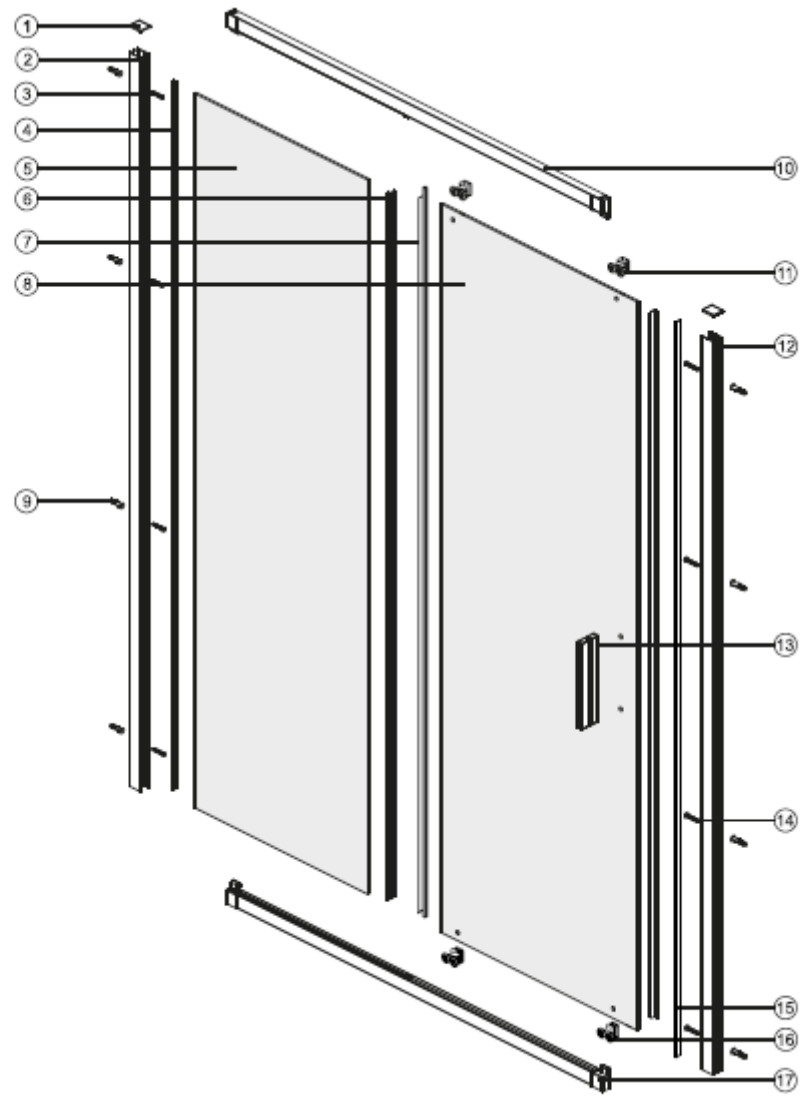

BLSPS – 80

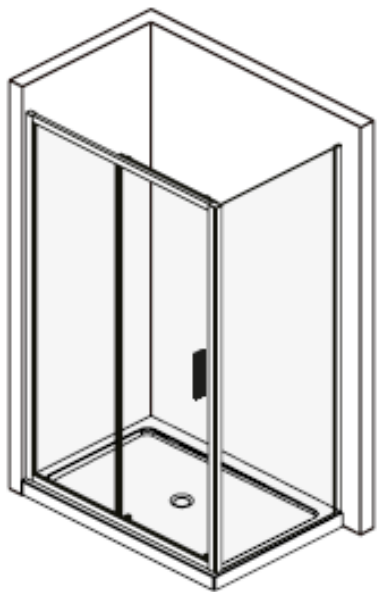

Číslo dílu	Název v MN	Počet	SIČ	Název
SP1	Profile cap	1	XND0000062	Krytka profilu SJ559
SP2	Wall jamb	1	XND0000063	Ustavovací profil, JG-AL0408-07 (1950 mm)
SP3	Squeeze gasket	1	XND0000050	Těsnící pr. R1001C (1950 mm)
SP4	Fixed panel	1	XND0000089	Sklo 6,0x1950x752 čiré BL-S22 Ravak-13
SP5	Profile cap L/R	1	XND0000023	Krytka profilu SJ1048L
SP5	Profile cap L/R	1	XND0000024	Krytka profilu SJ1048R
SP6	ST4x30 Screw	4	XND0000093	Vrut BLS 4x30
SP7	Glass wedge spacer	2	XND0000047	Podložka SJ183
SP8	Washer	4	XND0000090	Podložka pr.10x5x1
SP9	Corner profile	1	XND0000007	Rohový profil JG-AL0886-04 (1950 mm)

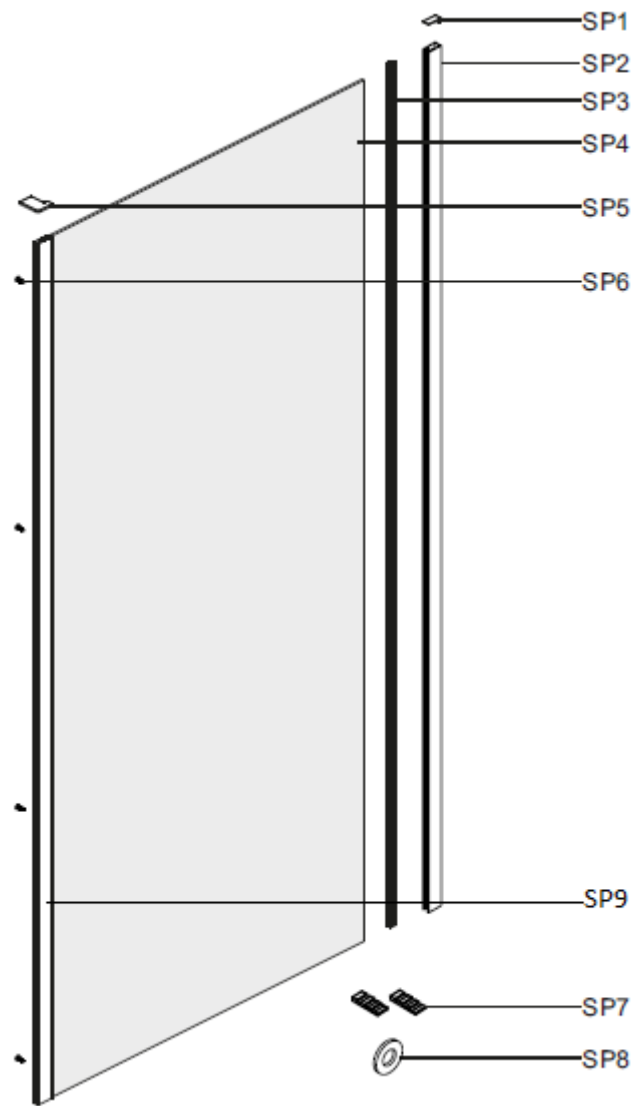

BLSPS – 90

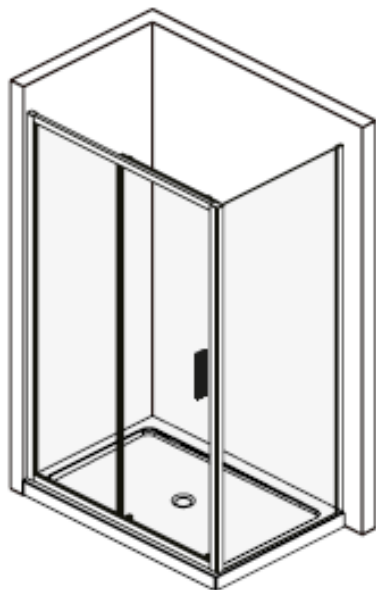

Číslo dílu	Název v MN	Počet	SIČ	Název
SP1	Profile cap	1	XND0000062	Krytka profilu SJ559
SP2	Wall jamb	1	XND0000063	Ustavovací profil, JG-AL0408-07 (1950 mm)
SP3	Squeeze gasket	1	XND0000050	Těsnící pr. R1001C (1950 mm)
SP4	Fixed panel	1	XND0000088	Sklo 6,0x1950x852 čiré BL-S22 Ravak-12
SP5	Profile cap L/R	1	XND0000023	Krytka profilu SJ1048L
SP5	Profile cap L/R	1	XND0000024	Krytka profilu SJ1048R
SP6	ST4x30 Screw	4	XND0000093	Vrut BLS 4x30
SP7	Glass wedge spacer	2	XND0000047	Podložka SJ183
SP8	Washer	4	XND0000090	Podložka pr.10x5x1
SP9	Corner profile	1	XND0000007	Rohový profil JG-AL0886-04 (1950 mm)

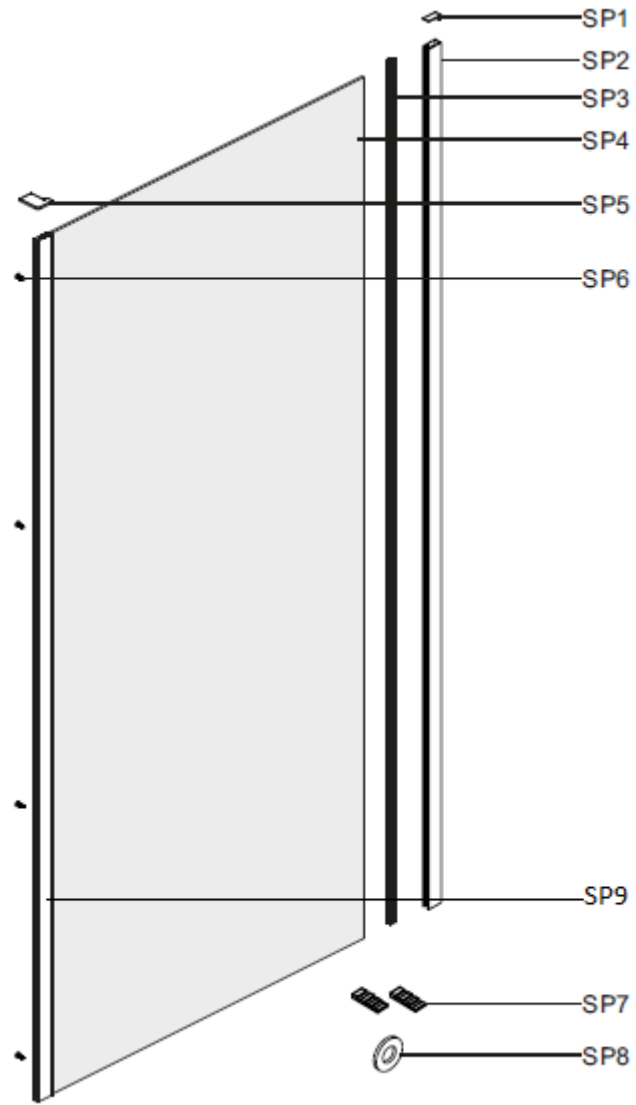

RAVAK a.s., Obecnická 285, 261 01 Píbram I, ČR
tel.: +420 318 427 111, fax: +420 318 427 278, e-mail: info@ravak.cz, web: www.ravak.cz

RAVAK SLOVAKIA spol. s r.o., Einsteinová 11, 851 01 Bratislava
tel.: +421 2 / 444 550 01, fax: +421 2 / 444 550 02, e-mail: obchod@ravak.sk, web: www.ravak.sk

RAVAK POLSKA s.a., Kalęczyn 2B., ul. Radziejowicka 124, 05-825 Grodzisk Mazowiecki, POLSKA
tel.: 22 / 755 40 30, fax: 22 / 755 43 90, e-mail: info@ravak.pl, web: www.ravak.pl

RAVAK Hungary Kft., 1142 Budapest, Erzsébet királyné útja 125, HUNGARY
tel.: 06 (1) 223 13 15, 06 (1) 223 13 16, fax: 06 (1) 223 13 14, e-mail: info@ravak.hu, web: www.ravak.hu

Ravak Gesellschaft für Sanitärprodukte mbH, Alexanderstrasse 58, D - 45472 Mülheim an der Ruhr
Tel. (0208) 37789-30 Fax. (0208) 37789-55, e-mail: info@ravak.de, web: www.ravak.de

RAVAK a.s., Representative Office in Ukraine, 21 Dniprovska Naberezhna str., 2nd floor, 02081, Kyiv, Ukraine
tel.: 00380 44 2203232, 00380 44 3605200, fax: 00380 44 2204343, e-mail: ravak@ravak.kiev.ua, web: www.ravak.ua

OOO RAVAK ru, ul. Staropetrovskiy pr. 7A, Moskva 125 130,
tel./fax: 007 495 710 82 23, 007 495 450 12 77, e-mail: ravak@inbox.ru, web: www.ravak.com

RAVAK®

RAVAK a.s., Obecnická 285, 261 01 Píbram I
tel.: +420 318 427 200, +420 318 427 111 fax: +420 318 427 269
info@ravak.cz, www.ravak.com

Výrobce si vyhrazuje právo změny ceny, technických parametrů, či dalších skutečností
bez předchozího upozornění a nenesé odpovědnost za tiskové chyby.

Version: 01022019